



**PLEASE SAVE THIS
MANUAL FOR
FUTURE REFERENCE.**

READ THIS MANUAL CAREFULLY.
SEE INSIDE COVER FOR IMPORTANT
INFORMATION ABOUT THIS MANUAL.
KEEP INSTRUCTION WITH
APPLIANCE FOR FUTURE REFERENCE.

Compatible with ceiling mount and wall mount applications only.

Version 20240205

Warnings

PLEASE READ ALL INSTRUCTIONS PRIOR TO INSTALLING THE DÉCOR COVER OR USING HEATER.

This unit may cause a shock or possible ignition if service is attempted without first disconnecting its power source.

Keep electrical cords, drapery, furnishings and other combustible materials at least 3.3ft (1m) from the heater's front cover and away from sides and rear.

GOOD TO KNOW!

For optimal heater performance and longevity, a 15 minute cool down period is recommended after 4 hours of continuous usage.



WARNING

- Décor Cover are compatible with ceiling mount and wall mount applications only.
- Not applicable with flush mount applications.
- Do not install, remove, or perform maintenance to this décor cover while electrical power is switched on.
- Handle décor cover with care.
- Handle décor cover only once it's cooled
- Do not touch décor cover while the heater is operational

EUROfase

HEATING

Head Office:
33 West Beaver Creek Road, Richmond Hill, ON L4B 1L8 Canada
Tel: 1.800.660.5391
www.EurofaseHeating.com

Note: Eurofase Heating reserves the right to make changes to specifications, parts, components and equipment without prior notification. This Installation, operation and service manual may not be reproduced in any form without prior written consent from Eurofase Heating.

Contents

WARNINGS.....Page 2

GETTING STARTED.....Page 4

INSTALLATION INSTRUCTIONS.....Page 5

 Step 1: Removal of standard grillPage 5

 Step 2: Décor cover installationPage 6

Getting Started

This décor cover is designed to work with all EF heater series. Eurofase Heater offers custom décor cover designs, please contact us for details.

Please read the entire décor cover installation manual to ensure safe operation.



Décor Cover is compatible with ceiling mount and wall mount applications only. Not applicable for flush mount applications.

HEATER

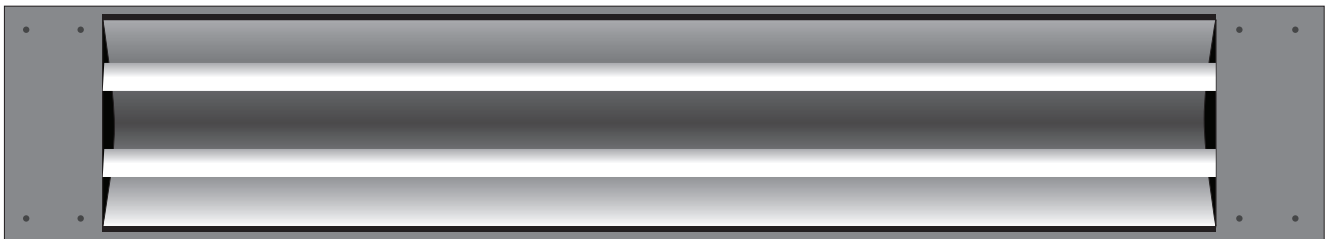

DÉCOR COVER

Front

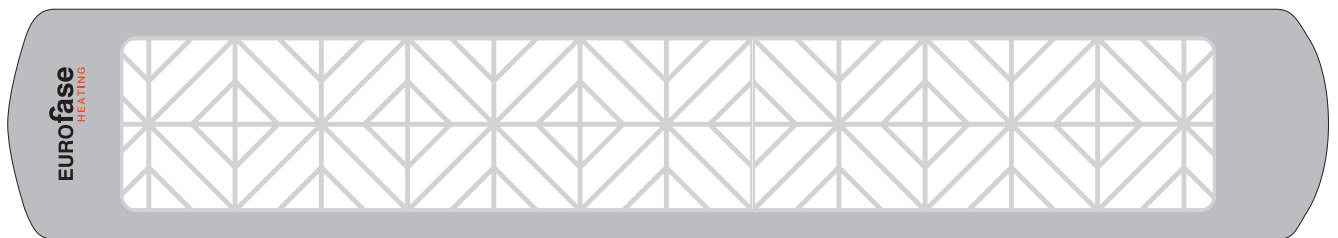

Inside

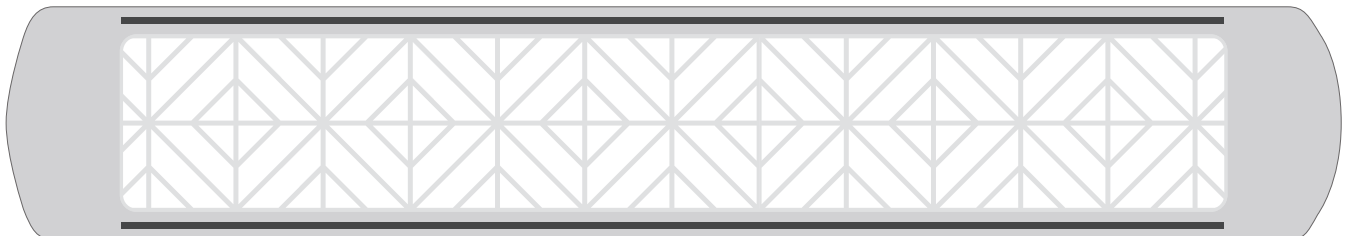

STEP 1: Removal of standard grill

Remove the standard grill by squeezing the middle of the grill, flip it up and slide the tabs out.

1. HEATER WITH STANDARD GRILL (indicated in green)

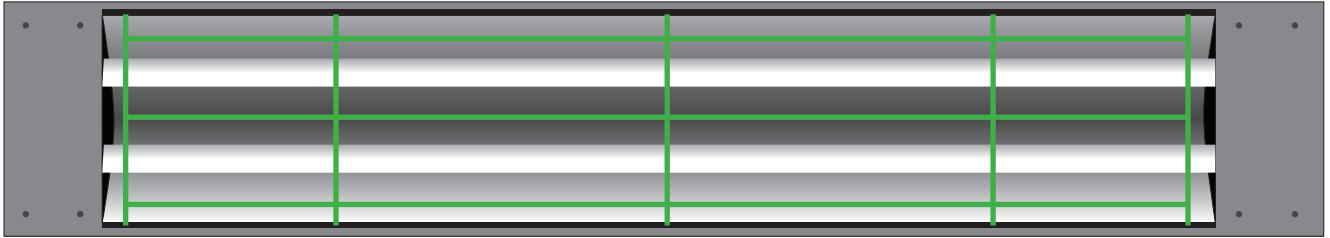

2. Squeeze the center bars together to release tabs and remove the grill

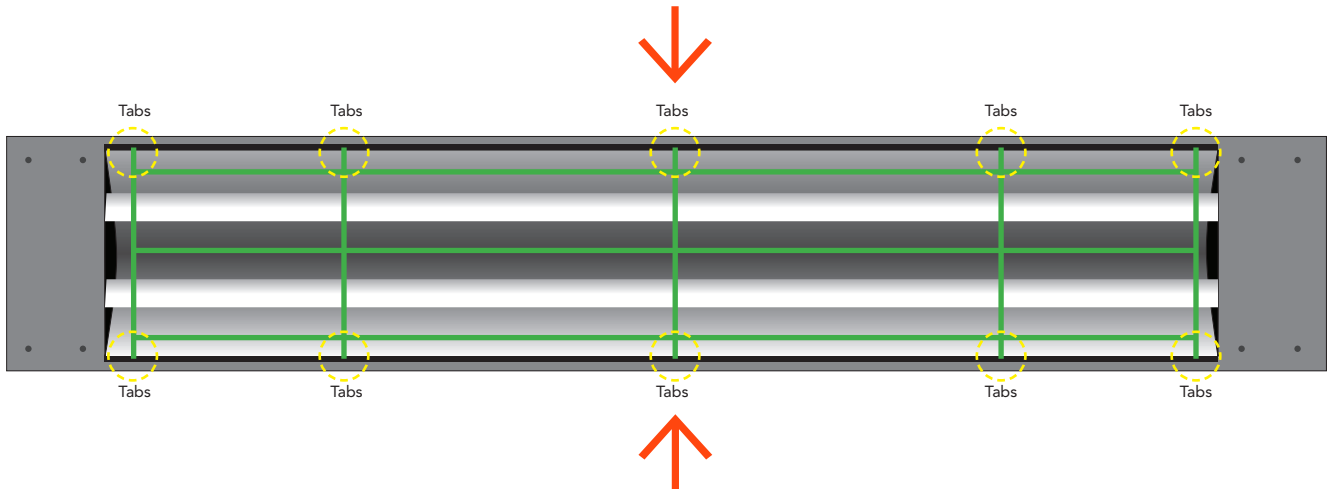

3. Standard grill removed

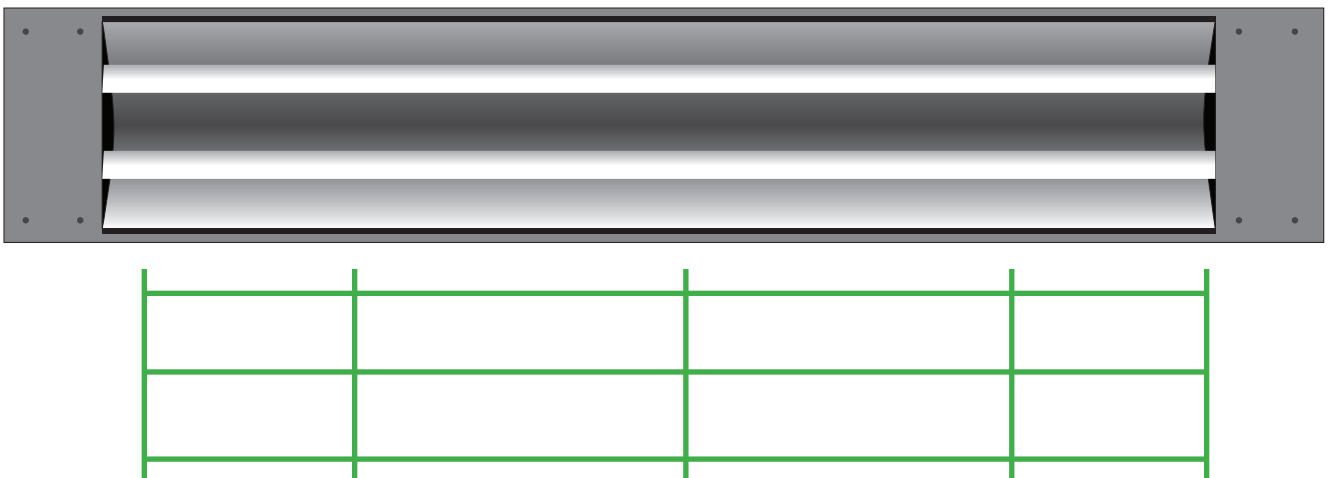

STEP 2: Décor cover installation

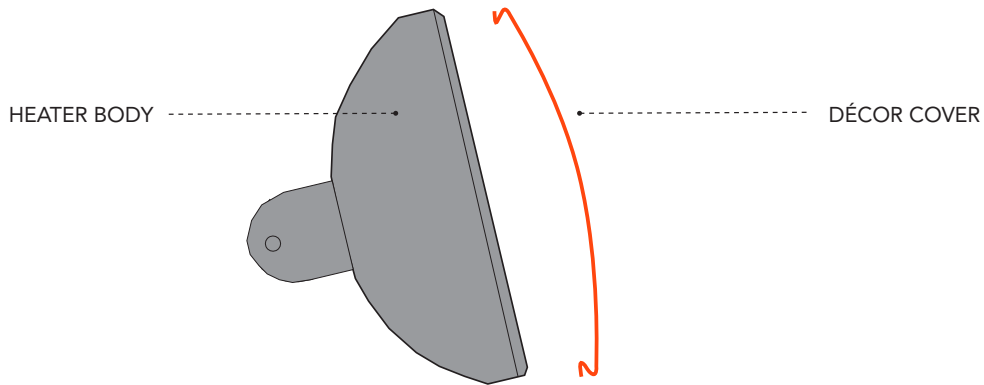

1. **START BY INSERTING THE DÉCOR COVER TO THE BOTTOM OF THE HEATER'S INDENTED SLOT.**

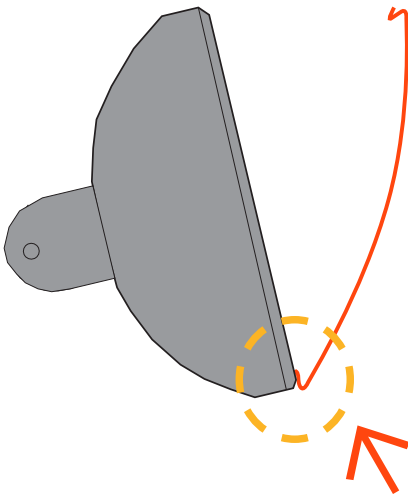

2. **APPLY SLIGHT PRESSURE DOWNWARDS TO SNUG FIT TOP PORTION OF THE DÉCOR COVER TO THE TOP INDENTED SLOT.**

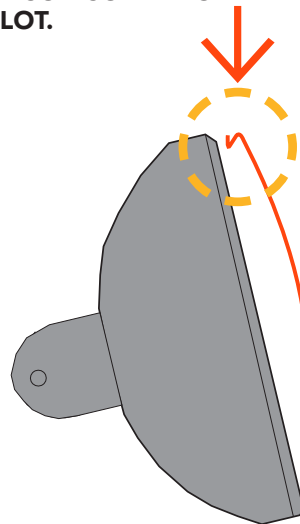

3. **INSPECT OVERALL DÉCOR COVER TO MAKE SURE IT IS SNUG FIT ONTO THE THE HEATER BODY.**

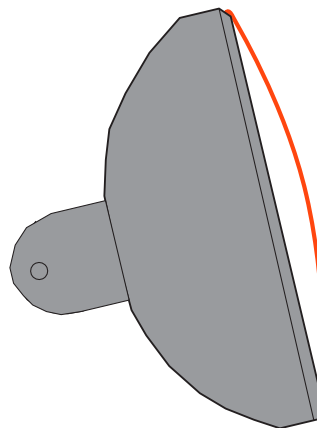

EUROfase **HEATING**

info@EurofaseHeater.com
1-800-660-5391

T. 905.695.2055
F. 905.695.2056

33 West Beaver Creek,
Richmond Hill, ON L4B 1L8

